

# DC158 Visual Presenter

## User Manual



### [Important]

To download the quick start guide, multilingual manuals, software or drivers, please visit Lumens website at <http://www.lumens.com.tw/goto.htm>

# Contents

<b>Copyright Information</b> .....	<b>3</b>
<b>Chapter 1 Precautions</b> .....	<b>4</b>
Safety Precautions .....	5
FCC Warning.....	5
<b>Chapter 2 Package Contents</b> .....	<b>6</b>
<b>Chapter 3 Product Overview</b> .....	<b>7</b>
3.1 Positioning the Presenter and Document.....	8
3.2 Correct Usage .....	8
<b>Chapter 4 Installation and Connections</b> .....	<b>9</b>
4.1 System Diagram .....	9
4.2 Connecting to External Devices .....	10
4.3 Getting Started.....	12
4.4 Installing application software.....	13
<b>Chapter 5 DIP Switch</b> .....	<b>14</b>
5.1 Connecting to a Projector or Monitor.....	14
5.2 Connecting to a TV .....	15
<b>Chapter 6 Introduction to Control Panel/ Remote Control Buttons and On-Screen Menu</b> .....	<b>16</b>
6.1 Functions of Control Panel and Remote Control Buttons .....	16
6.2 On-screen Menu.....	17
<b>Chapter 7 Descriptions of Major Functions</b> .....	<b>19</b>
7.1 Switching Image Sources .....	19
7.2 Making Text Clearer and Photos More Colorful .....	19
7.3 Zoom in /out From an Image .....	19

7.4	Using Auto Focus .....	19
7.5	Adjusting the Brightness.....	19
7.6	Turning the Lamp on/off .....	20
7.7	Automatically Adjusting the Image to Optimal Brightness and Focal Length .....	20
7.8	Freezing Images.....	20
7.9	Capturing Images .....	20
7.10	Browsing Captured Images .....	20
7.11	Deleting Captured Images.....	21
7.12	Automatically Deleting Captured Images When the Device is Turned off (Auto Erase).....	21
7.13	Panning Across a Live Image (PAN) .....	22
7.14	Playing a Slides (Slide Show) .....	22
7.15	Comparing Live Images with Stored Images (PBP) .....	23
7.16	Restoring Factory Default Settings (Factory Reset).....	24
7.17	Computer- Related Functions .....	24
<b>Chapter 8</b>	<b>Connecting to a Microscope .....</b>	<b>30</b>
<b>Chapter 9</b>	<b>Troubleshooting.....</b>	<b>31</b>

# Copyright Information

---

Copyrights © Lumens Digital Optics Inc. All rights reserved.

Lumens is a trademark that is currently being registered by Lumens Digital Optics Inc.

Copying, reproducing or transmitting this file is not allowed if a license is not provided by Lumens Digital Optics Inc. unless copying this file is for the purpose of backup after purchasing this product.

In order to keep improving the product, Lumens Digital Optics Inc. hereby reserves the right to make changes to product specifications without prior notice. The information in this file is subject to change without prior notice.

To fully explain or describe how this product should be used, this manual may refer to names of other products or companies, nevertheless without any intention of infringement.

Disclaimer of warranties: Lumens Digital Optics Inc. is neither responsible for any possible technological, editorial errors or omissions, nor responsible for any incidental or related damages arising from providing this file, using, or operating this product.

# Chapter 1 Precautions

---

Always follow these safety instructions when setting up and using the visual presenter:

1. Do not place visual presenter in tilted position.
2. Do not place the visual presenter on an unstable trolley, stand or table.
3. Do not use the visual presenter near water or source of heat.
4. Use attachments only as recommended.
5. Use the type of power source indicated on the visual presenter. If you are not sure of the type of power available, consult your dealer or local electricity company for advice
6. Place the visual presenter on a place that it can be unplugged easily.
7. Always take the following precautions when handling the plug. Failure to do so may result in sparks or fire.
  - Ensure the plug is free of dust before inserting it into a socket.
  - Ensure that the plug is inserted into the socket securely.
8. Do not overload wall sockets, extensions leads or multi-way plug boards as this may cause fire or electric shock.
9. Do not place the visual presenter where the cord can be stepped on as this may result in fraying or damage to the lead or the plug.
10. Unplug the projector from the wall socket before cleaning. Use a damp cloth for cleaning. Do not use liquid or aerosol cleaners.
11. Do not block the slots and openings in the projector case. They provide ventilation and prevent the visual presenter from overheating. Do not place the visual presenter on a sofa, rug or other soft surface or in a built-in installation unless proper ventilation is provided.
12. Never push objects of any kind through cabinet slots. Never allow liquid of any kind to spill into the visual presenter.
13. Except as specifically instructed in this User Manual, do not attempt to operate this product by yourself. Opening or removing covers may expose you to dangerous voltages and other hazards. Refer all servicing to licensed service personnel.
14. Unplug the visual presenter during thunderstorms or if it is not going to be used for an extended period, do not place the visual presenter or remote control on top of heat-emitting equipment or heated objects such as a car and etc.

15. Unplug the visual presenter from the wall outlet and refer serving to licensed service personnel when the following situations happen:
  - If the power cable or plug becomes damaged or frayed.
  - If liquid is spilled into it or the visual presenter has been exposed to rain or water.



**<Note> Using an incorrect battery type in the remote control may result in breakdown. Follow your country’s instructions on how to dispose of used batteries.**

**■ Safety Precautions**

**Warning: To reduce the risk of fire or electric shock, do not expose this appliance to rain or moisture.**

This visual presenter has a 3-wire AC line Plug. This is a safety feature to ensure that the plug will fit into the power outlet. Do not try to disable this safety feature.

If the visual presenter will not be used for a long period of time unplug it from the power outlet.

	<b>CAUTION</b> <b>RISK OF ELECTRIC SHOCK</b>	
<p>Caution: To reduce the risk of electric shock. Do not remove cover (or back). No user-serviceable parts inside. Refer servicing to licensed service Personnel.</p>		
	<p>This symbol indicates that this equipment may contain dangerous voltage which could cause electric shock.</p>	

**■ FCC Warning**

NOTE: THE MANUFACTURER IS NOT RESPONSIBLE FOR ANY RADIO OR TV INTERFERENCE CAUSED BY UNAUTHORIZED MODIFICATIONS TO THIS EQUIPMENT. SUCH MODIFICATIONS COULD VOID THE USER'S AUTHORITY TO OPERATE THE EQUIPMENT.

# Chapter 2 Package Contents

DC158



Download & Safety  
Instruction



USB Cable



Extension USB Cable

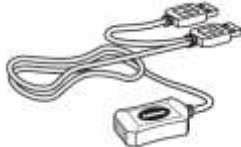

Microscope Adapter



Backlight (Optional)



Quick Start Guide



(To download this manual in  
other languages, visit  
Lumens website)

Remote Control



C-Video Cable



Accessory Pouch



RS-232 Adapter  
(Optional)

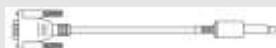

Padded Carry Bag  
(Optional)



Remote Control Holder



VESA Base  
Installation Guide



VGA Cable



Power Cord

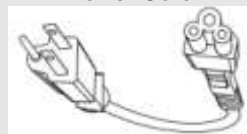

Appearance may vary in  
different countries

Pouch

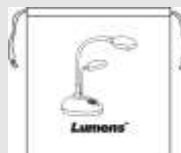

# Chapter 3 Product Overview

---

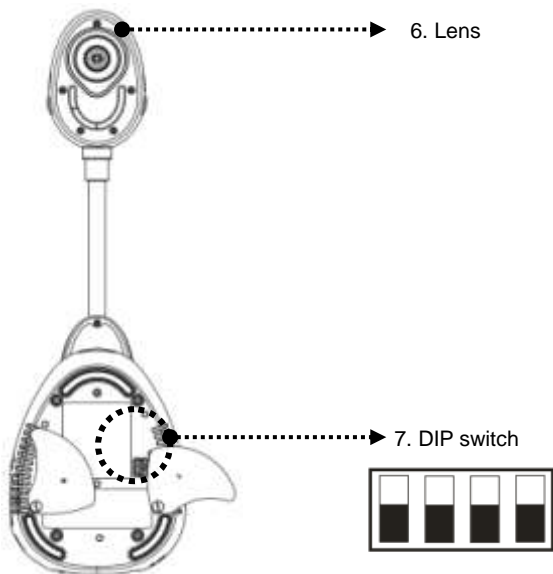
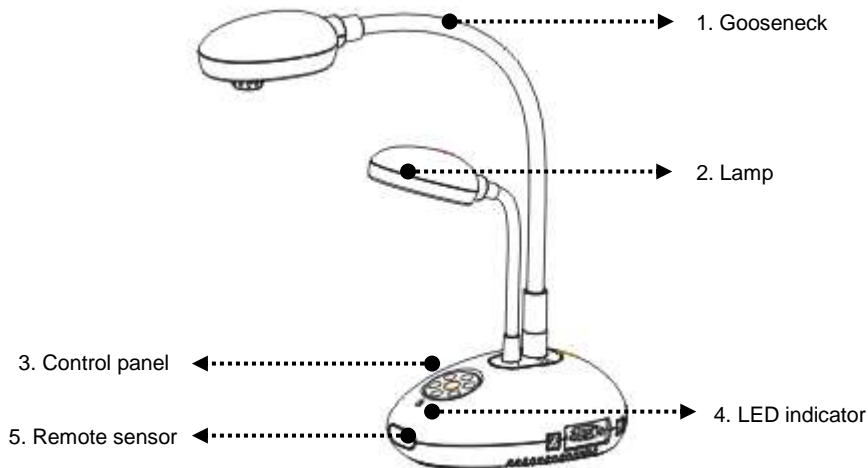

### 3.1 Positioning the Presenter and Document



### 3.2 Correct Usage

\* About 400mm distance between camera and the desktop is recommended.

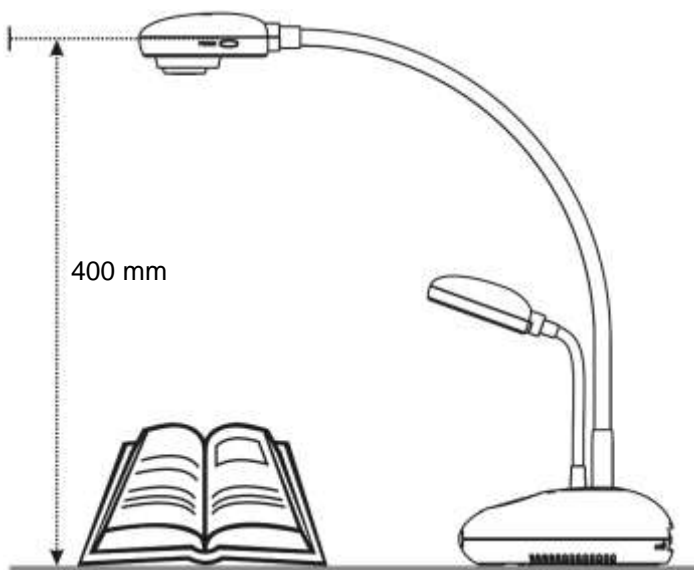

# Chapter 4 Installation and Connections

## 4.1 System Diagram

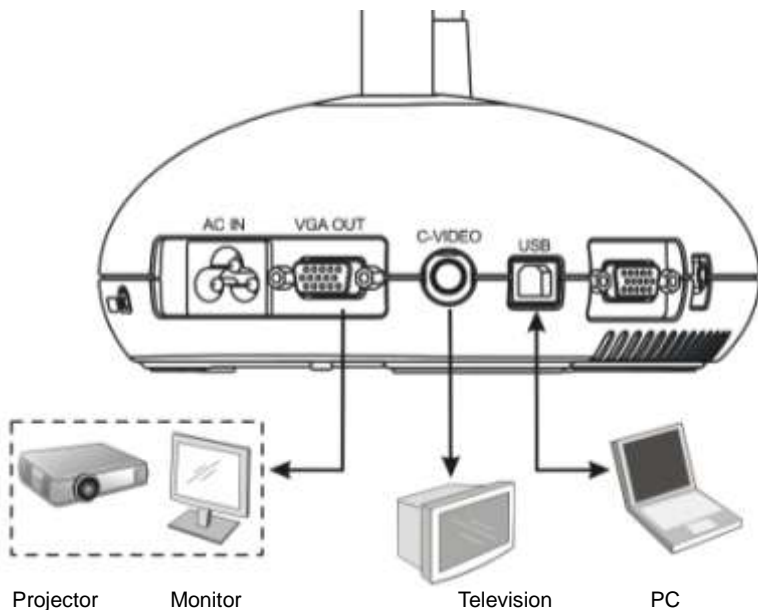

Projector

Monitor

Television

PC

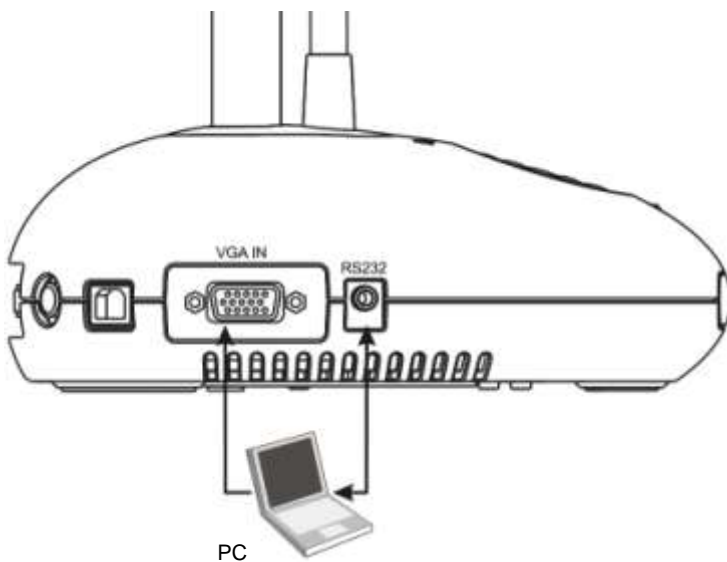

PC

## 4.2 Connecting to External Devices

### 4.2.1 Step 1: Connect the power cord from the AC In on the DC158 to the power outlet

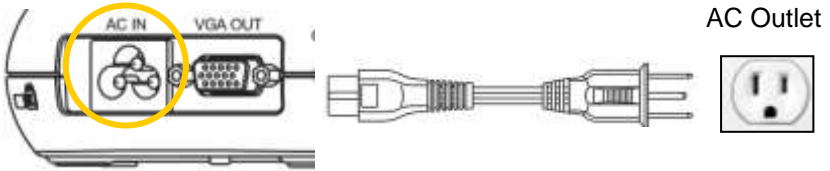

<Note>: Appearance of the power cord may vary depending on country/region.

### 4.2.2 Step 2: Connection projector with other hardware devices

#### ➤ Connecting to a Projector or Monitor

- Connect the VGA cable from the VGA OUT port on the DC158 to the VGA IN port on the projector or monitor.

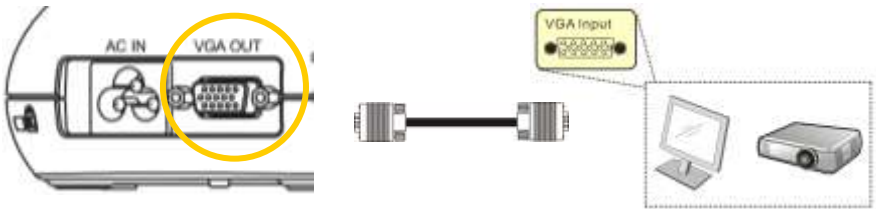

#### ➤ Connecting to a TV

1. Connect the C-VIDEO cable from the C-VIDEO port on the DC158 to the C-VIDEO port on the TV.

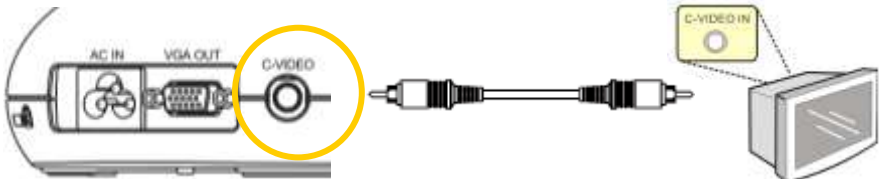

## 2. Adjust DIP Switch Setting

- NTSC: U.S.A., Taiwan, Panama, Philippine, Canada, Chile, Japan, Korea and Mexico.

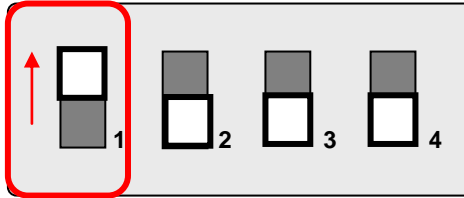

- PAL: Country/region not listed above.

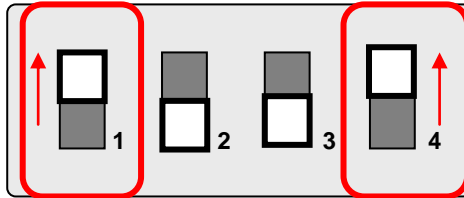

<Note> The on-screen display (OSD) is not available in C-VIDEO.  
Some functions are not available on the control panel and the remote control in this mode.

<Note> VGA OUT is not supported once C-VIDEO is enabled.

3. DIP switch settings will not available until the DC158 has been restarted.

## ➤ Connecting to a Computer

1. Connect the USB cable from the USB port on the DC158 to the USB port on the computer. Next, download the **Ladibug™** program from the Lumens website (<http://www.lumens.com.tw/goto.htm>).

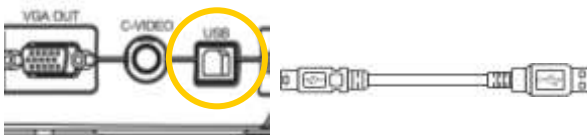

2. Connect the VGA cable from the VGA IN port on the DC158 to the VGA OUT port on the computer.

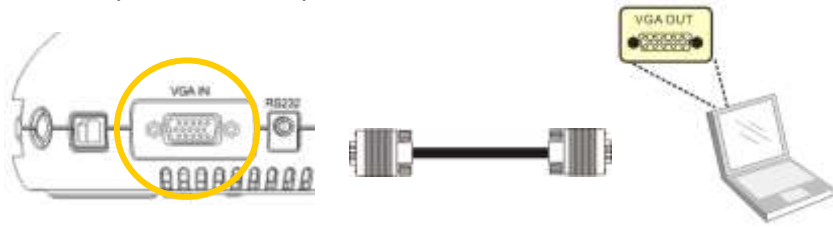

3. Connect the RS-232 Adapter (Optional) to the RS-232 port on the DC158 and the RS-232 port on the computer.

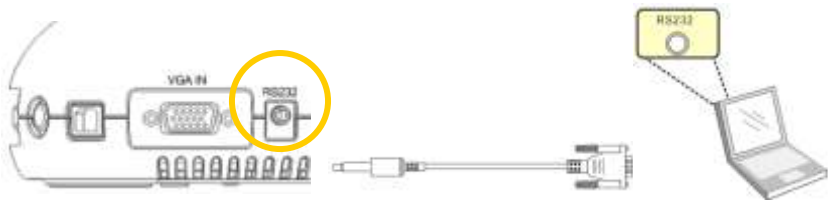

## 4.3 Getting Started

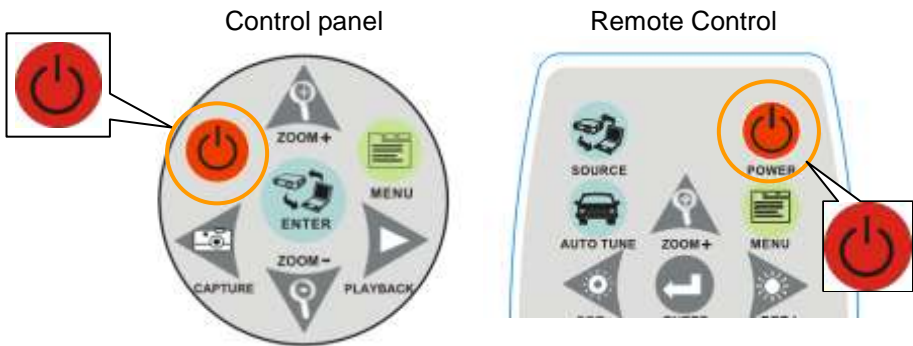

- To turn on the DC158 with the **remote control**, aim at the remote sensor at the DC158 and press the Power button.
- Once the DC158 is powered on, the LED on the projector will flash a few times and then remain lit. Contact your distributor if the LED fails to light.

## 4.4 Installing application software

After installing the USB driver and application software, you can use the following functions:

- Control the DC158.
- Capture and record images.
- Annotate the image, highlight important details and save it.
- Support the full screen function.

**<Note>: Please refer to Ladibug™ software user manual for installation steps and software operation.**

# Chapter 5 DIP Switch

---

<Note>: You must restart the DC158 in order for DIP switch configuration to take effect.

## 5.1 Connecting to a Projector or Monitor

### 5.1.1 SXGA output (factory default):

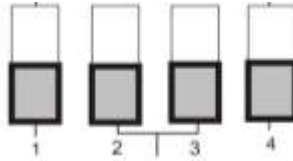

### 5.1.2 WXGA output

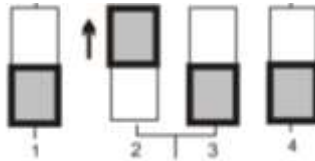

### 5.1.3 XGA output

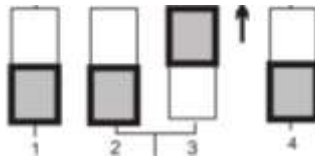

### 5.1.4 Reserved

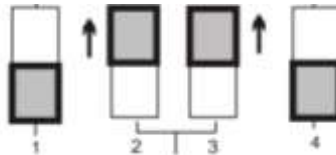

## 5.2 Connecting to a TV

### 5.2.1 NTSC Settings: U.S.A., Taiwan, Panama, Philippines, Canada, Chile, Japan, Korea, and Mexico

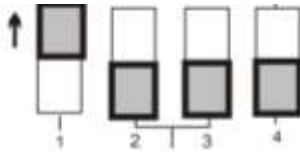

### 5.2.2 PAL Settings: Countries/regions not listed above

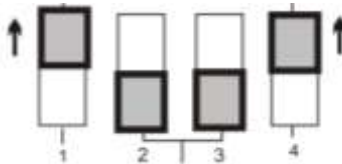



<Note> VGA OUT is not supported once C-VIDEO is enabled.

# Chapter 6 Introduction to Control Panel/ Remote Control Buttons and On-Screen Menu

## 6.1 Functions of Control Panel and Remote Control Buttons

<Remark> The functions below are listed alphabetically

Name	Function Descriptions	Operation
	Turns the visual presenter on and off.	Remote control / Control panel
	Moves up, down, left or right to select the needed function.	Remote control / Control panel
AF	Automatically adjusts the focal length between the lens and the object being projected.	Either side of the unit's lens
AUTO TUNE	Automatically adjusts to the optimal brightness and focal length.	Remote Control
BRT+/-	Adjusts brightness of the image.	Remote Control
CAPTURE	Captures the image to the internal memory.	Remote control / Control panel
DELETE	Deletes images stored in the internal memory.	Remote Control
ENTER	Accesses/Activates functions.	Remote control / Control panel
FREEZE	Freezes the current image temporarily on the screen. Press again to unfreeze.	Remote Control
MENU	Activates the on-screen menu/exits the menu.	Remote control / Control panel
PAN	Moves across part of the live image.	Remote Control
PBP	Allows users to compare live images with captured image files.	Remote Control
PLAYBACK	Plays captured images.	Remote control / Control panel
ROTATE	Rotates the image by 0°/90°/180°/270°	Remote Control
SLIDE SHOW	Plays the photos in a slide show.	Remote Control
SOURCE	Switches between different image sources: 1. Live images (default). 2. PC.	Remote control / Control panel
ZOOM +/-	Increases or decreases image size.	Remote control / Control panel

## 6.2 On-screen Menu

<Note> Press [**Menu**] on the **remote control** or **control panel** to enter the on-screen menu, **The bold underlined values in the following table are defaults.**

1st Level Major Items	2nd Level Sub items	3rd Level Adjustment Values	Function Descriptions
Display	Auto Tune	Enter	Press [ENTER] to automatically adjust to the optimal brightness and focal length.
	Focus	0~Max	Use the left and right arrow keys to adjust focal length.
	Mode	<u>Normal</u> /Slide/Film/Microscope	Use the left and right arrow keys to select the image mode.
	Photo/Text	<u>Photo</u> /Text/Gray	Use the left and right arrow keys to select the photo/text/gray mode.
	PBP	Enter	Press [ENTER] to immediately activate the image comparison mode.
	PAN	ON / <u>OFF</u>	Use the left and right arrow keys to move across the live image.
	Rotate	<u>0°</u> /90°/180°/270°	Use the left and right arrow keys to rotate the image.
Storage	Slide Show	Enter	Press [ENTER] to play the photos stored in the internal memory in slide show mode.
	Slide Show Effect	<u>Off</u> /Shutter/Right/Down/Side/Open	Use the left and right arrow keys to select a page-flipping mode.
	Delay	<u>1 Sec</u> /3 Sec/5 Sec/10 Sec/ Manual	Use the left and right arrow keys to select the timing of page flips. (Select manual mode to switch images manually.)
	Delete All	Yes/ <u>No</u>	Use the left and right arrow keys to select desired image, and then press [ENTER] to confirm the deletion of the photo.
	Format	Yes/ <u>No</u>	Use the left and right arrow keys to select, and then format the internal memory.

	<b>Auto Erase</b>	ON/ <u>OFF</u>	Use the left and right arrow keys to enable/disable the auto erase function, which automatically deletes all stored images upon system shutdown.
<b>Setting</b>	<b>USB Transfer</b>	<u>Camera</u> /Storage Device	Use the left and right arrow keys to select the USB transfer mode.
	<b>Lamp</b>	<u>ON</u> /OFF	Use the left and right arrow keys to turn the lamp on/off.
	<b>AE</b>	<u>ON</u> /OFF	Use the left and right arrow keys to turn the Auto Erase (AE) on/off.
	<b>AWB</b>	Enter	Press [ENTER] to activate Automatic White Balance (AWB) immediately.
	<b>Night Vision</b>	ON / <u>OFF</u>	Use the left and right arrow keys to select the night vision mode.
<b>Advance</b>	<b>Language</b>	<ol style="list-style-type: none"> <li>1. <u>English</u></li> <li>2. 繁體中文</li> <li>3. Deutsch</li> <li>4. Français</li> <li>5. Español</li> <li>6. Русский</li> <li>7. Nederlands</li> <li>8. Suomi</li> <li>9. Polski</li> <li>10. Italiano</li> <li>11. Português</li> <li>12. Svenska</li> <li>13. ČESKY</li> </ol>	<u>English</u> Traditional Chinese German French Spanish Russian Dutch Finnish Polish Italian Portuguese Swedish Czech Use the left and right arrow keys in the language option to select the preferred language.
	<b>Preset Load</b>	Yes/ <u>No</u>	Read the value of the current image mode. Use the left and right arrow keys to select, and then confirm by pressing [ENTER].
	<b>Preset Save</b>	Yes/ <u>No</u>	Store the value of the current image mode. Use the left and right arrow keys to select, and then confirm by pressing [ENTER].
	<b>Factory Reset</b>	Yes/ <u>No</u>	Use the left and right arrow keys to select, and then confirm by pressing [ENTER] to restore factory defaults.

# Chapter 7 Descriptions of Major Functions

---

## 7.1 Switching Image Sources

Live image is the default image source. Press [SOURCE] on the **remote control** or **control panel** to switch between image sources:

1. Live images (default).
2. PC.

## 7.2 Making Text Clearer and Photos More Colorful

Photo (**Photo mode**) is selected by default in the [Photo/Text/Gray] mode

- [Photo] (Default): View photos or text with photos in this mode to enhance colors in photos.
- [Text]: View text files in this mode to make text clearer.
- [Gray]: View grayscale or black and white photos in this mode.

Change settings with the **remote control** or **control panel**:

1. Press [MENU] to enter the on-screen menu.
2. Press [▶] or [◀] to select [Display].
3. Press [▼] to select among [Photo/Text/Gray] modes. (Refer to the [description above](#) for the best choice).
4. Press [▶] or [◀] to move among [Photo/Text/Gray] modes.
5. Press [MENU] to exit.

## 7.3 Zoom in /out From an Image

1. Press [ZOOM+] on the **remote control** or **control panel** to zoom in to an image.
2. Press [ZOOM-] on the **remote control** or **control panel** to zoom out from an image.

## 7.4 Using Auto Focus

1. From the **Control Panel**, press the [FOCUS] button on the right side of the lens.

## 7.5 Adjusting the Brightness

1. From the **Remote Control** or **Control Panel**, press [BRT+] to make it

brighter.

2. From the **Remote Control** or **Control Panel**, press [BRT-] to darken the image.

## 7.6 Turning the Lamp on/off

From the **remote control** or **control panel**:

1. Press [MENU] to enter the on-screen menu.
2. Press [▶] or [◀] to select [Setting].
3. Press [▼] to select [Lamp] modes.
4. Press [▶] or [◀] to turn [ON]/[OFF].
5. Press [MENU] to exit.

## 7.7 Automatically Adjusting the Image to Optimal Brightness and Focal Length

**From the remote control:**

1. Press [AUTO TUNE] for the optimal brightness and focal length.

**From the control panel:**

1. Press [MENU] to enter the on-screen menu.
2. Press [▶] or [◀] to select [Display].
3. Press [▼] to select among [Auto Tune] modes.
4. Press [ENTER].
5. Press [MENU] to exit.

## 7.8 Freezing Images

1. Press [FREEZE] on the **remote control** to freeze the current image on the screen. Press again to unfreeze.

## 7.9 Capturing Images

1. Press [CAPTURE] on the **remote control** or **control panel** to capture and save an image.

## 7.10 Browsing Captured Images

1. Press [PLAYBACK] on the **remote control** or **control panel** to display thumbnails of all captured images.

2. Press [▲] or [▼] or [◀] or [▶] to select the thumbnail you want you browse.
3. Press [ENTER] to access the full-screen display of the image.
4. Press [▶] or [◀] to browse the through saved images.
5. Press [PLAYBACK] to exit.
6. Press [MENU] to exit.

## 7.11 Deleting Captured Images

### **From the remote control:**

1. Press [PLAYBACK].
2. Press [▲] or [▼] or [◀] or [▶] to select the desired thumbnail for deletion.
3. Press [DELETE] to delete the selected file.
4. Press [MENU] to exit.

### **From the control panel:**

1. Press [MENU] to enter the on-screen menu.
2. Press [▶] or [◀] to select [Storage].
3. Press [▼] to select [Delete All].
4. Press [▶] or [◀] to select [Yes].
5. Press [ENTER] to confirm selection.
6. Press [MENU] to exit.

## 7.12 Automatically Deleting Captured Images When the Device is Turned off (Auto Erase)

### **From the remote control or control panel:**

1. Press [MENU] to enter the on-screen menu.
2. Press [▶] or [◀] to access the [Storage] menu.
3. Press [▲] or [▼] to enable [Auto Erase].
4. Press [▶] or [◀] to select among [ON] modes.
5. Press [MENU] to exit.

## 7.13 Panning Across a Live Image (PAN)

<Note> Panning and zooming are not available in Microscope Mode.

**From the remote control:**

1. Press [PAN] on the **remote control** to zoom in a part of a live image.
2. Press [▲] or [▼] or [◀] or [▶] to move around the partially zoomed-in image.
3. Press [PAN] to exit the partially zoom in mode.

**From the control panel:**

1. Press [MENU] to enter the on-screen menu.
2. Press [▶] or [◀] to select the [Display] menu.
3. Press [▼] to select [PAN].
4. Press [▶] or [◀] to select among [ON] modes.
5. Press [MENU] to exit.
6. Press [▲] or [▼] or [◀] or [▶] to move around the partially zoomed-in image.

## 7.14 Playing a Slides (Slide Show)

### 7.14.1 Using the slide show effect:

1. Press [MENU] on the **remote control** or **control panel** to enter the on-screen menu.
2. Press [▶] or [◀] to select the [Storage] menu.
3. Press [▼] to enable [Slide Show Effect].
4. Press [▶] or [◀] to select page-flipping mode among [Off / Shutter / Right / Down / Side / Open].
5. Press [MENU] to exit.

### 7.14.2 Setting delay time

1. Press [MENU] on the **remote control** or **control panel** to enter the on-screen menu.
2. Press [▶] or [◀] to select the [Storage] menu.
3. Press [▼] to enable [Delay].
4. Press [▶] or [◀] to select page-flipping interval [1 Sec/3 Sec/5 Sec/10 Sec/Manual].
5. Press [MENU] to exit.

### 7.14.3 Start/Pause/Stop Playing Images

<Note> Images over 8MB cannot be played. During playback, the [ROTATE] function can be activated to rotate the images.

**From the remote control:**

1. Press [SLIDE SHOW] to start playback.
2. Press [ENTER] to pause playback.
3. Press [ENTER] again to continue playback.
4. Press [SLIDE SHOW] again to stop playback.

**From the control panel:**

1. Press [MENU] to enter the on-screen menu.
2. Press [▶] or [◀] to select the [Storage] menu.
3. Press [▼] to enable [Slide Show].
4. Press [ENTER] to play back images.
5. Press [ENTER] to pause playback.
6. Press [ENTER] again to continue playback.
7. To stop playing, repeat Steps 1 to 4.

## 7.15 Comparing Live Images with Stored Images (PBP)

This function allows you to simultaneously display a live image on the right side and a storage image on the left side for comparison.

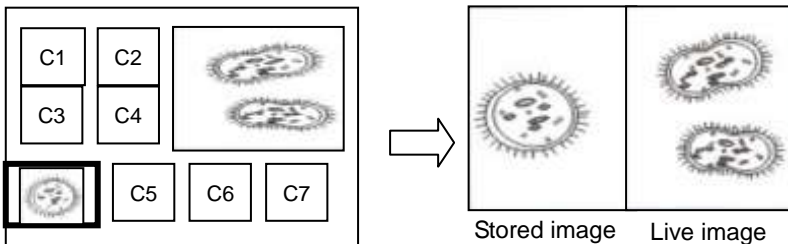

**From the remote control:**

1. Press [PBP] to enter the photo selection screen.
2. Press [▲] or [▼] or [◀] or [▶] to select the file to be compared.
3. Press [ENTER] to activate image comparison.
4. Press [ENTER] to switch between the stored image and the live image.

5. Press [▶] or [◀] to move the selected image left or right.
6. Press [ZOOM+/-] to zoom in/out from the live image
7. Press [PBP] to return to the stored image screen.
8. Press [MENU] to exit.

#### **From the control panel**

1. Press [MENU] to enter the on-screen menu.
2. Press [▶] or [◀] to select the [Display] menu.
3. Press [▼] to select [PBP].
4. Press [PBP] to enter the photo selection screen.
5. Press [▲] or [▼] or [◀] or [▶] to select the desired file for comparison.
6. Press [ENTER] to activate image comparison.
7. Press [▶] or [◀] to move through selected images.
8. Press [ZOOM+/-] to zoom in/out from the live image
9. Press [PBP] to return to the stored image screen.
10. Press [MENU] to exit.

## **7.16 Restoring Factory Default Settings (Factory Reset)**

#### **Use the remote control or control panel:**

1. Press [MENU] on the **remote control** or **control panel** to enter the on-screen menu.
2. Press [▶] or [◀] to select the [Advance] menu.
3. Press [▼] to select [Factory Reset].
4. Press [▶] or [◀] to select [Yes].
5. Press [ENTER] to activate.

## **7.17 Computer- Related Functions**

Ensure that the USB cable is connected and the drivers are installed before using the computer-related functions. Refer to [4.2.2 Connecting to external devices](#) and [4.4 Installing application software in Chapter 4 Installation and Connections](#) in this user manual.

## 7.17.1 Inserting a Photo in the MS-Paint Application

1. Click [File> From Scanner or Camera] in the MS-Paint application as shown in the bottom left figure.

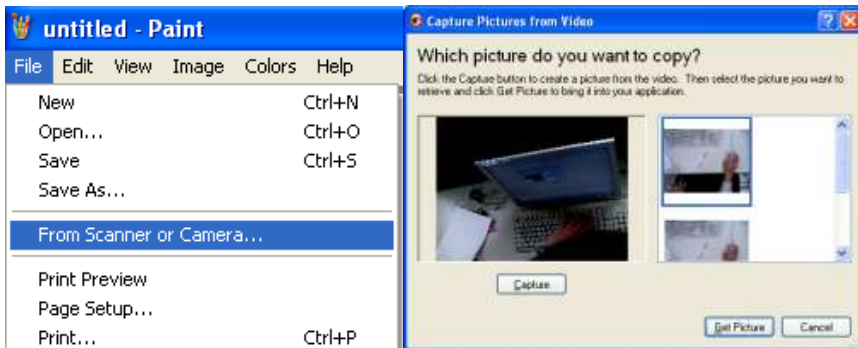

2. Click on [Get Picture] to finish, as shown in the top right figure.

## 7.17.2 Inserting a Photo in a Microsoft Word Document

1. Click [Insert / Image / From Scanner or Camera] in the Microsoft Word application.



2. Select [Visual Presenter V2] and click [Custom Insert].



3. Click [Get Picture] to finish.



### 7.17.3 Changing the Setting of the DC158 and then Capturing a Photo in Microsoft Word

1. Click [Insert /Image /From Scanner or Camera] in **Microsoft Word**.

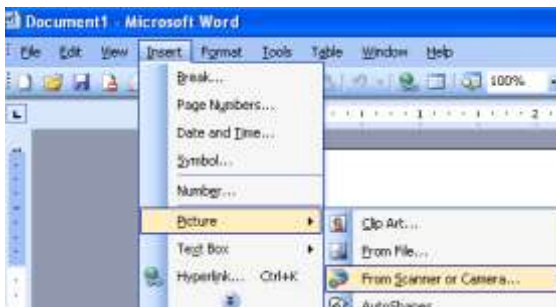

2. Select [Visual Presenter V2 TWAIN] and click [Custom Insert].



3. A window displaying a live image (see below) will appear.

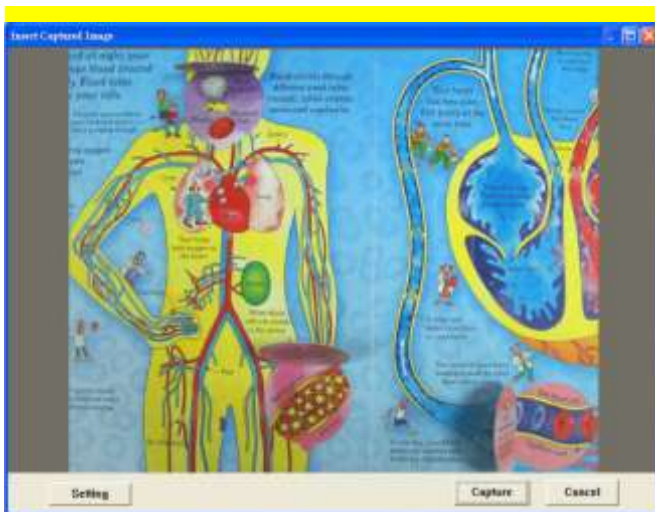

4. Press [Setting]: When the Camera Settings window pops up, the live image can be adjusted. The operation is identical from both the remote control and the control panel. Refer to [Chapter 6 Control Panel/Remote Control Buttons and On-screen Menu for more information](#).
5. Press [Capture] to capture images in **Microsoft Word**.
6. Press [Cancel] to exit.

#### 7.17.4 Setting up the DC158 as a Webcam for Skype

The DC158 can be used as a webcam for instant message (IM) software such as **Skype** and **MSN**. Operation with any IM program is similar. In Skype, for example, complete the following steps:

1. Open the **Skype application** and choose [Tools] > [Options].
2. Select [Video Settings], check [Start my video automatically when I am in a call] and select [Visual Presenter V2] as the desired webcam, as shown below.

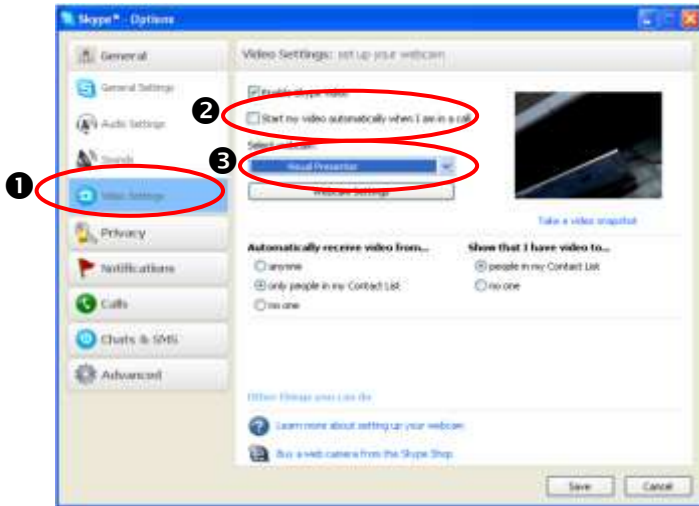

Call your desired contact. When both parties are connected, **Skype** will display the video screen.



### 7.17.5 Setting the DC158 as a PC Camera

1. Open **My Computer** and click on [Visual Presenter V2] to display a live image.

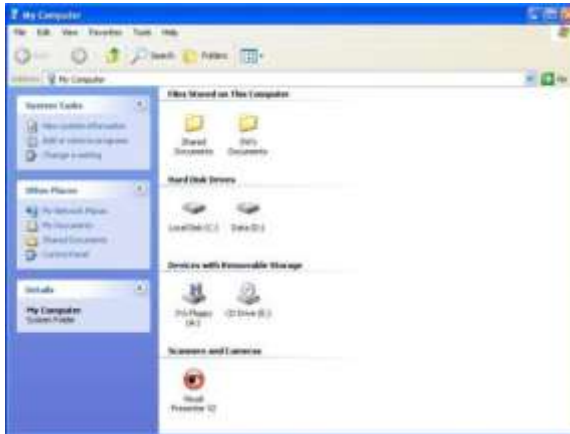

### 7.17.6 Connecting to an Interactive Whiteboard

To connect to an Interactive Whiteboard, go to the Lumens website and download the reference guide for your desired brand.

(<http://www.lumens.com.tw/goto.htm>)

# Chapter 8 Connecting to a Microscope

---

- 1 Mount the **microscope adaptor** in the accessories pack onto the microscope  
<Note> The Microscope adapter fits eyepieces of about Ø28.4mm.
- 2 Connect the lens of the DC158 to the **microscope adaptor**.



- 3 Select the Microscope mode
  - 3.1. From the **control panel** or **remote control**
    - 3.1.1. Press [MENU] to enter the on-screen menu.
    - 3.1.2. Press [▶] or [◀] to select [Display].
    - 3.1.3. Press [▼] to select among [Mode] modes.
    - 3.1.4. Press [▶] or [◀] to select [Microscope].
- 4 If the image is fuzzy:
  - 4.1. Adjust the focus of microscope.
  - 4.2. Press the [FOCUS] button on either side of the DC158 lens to activate the auto focus.

# Chapter 9 Troubleshooting

---

This chapter outlines possible solutions to common problems. For other issues, contact your dealer or service center.

No.	Problems	Solutions
1	<b>No power signal</b>	Check that the power cord is securely connected to the wall socket and the unit.
2	<b>No image output from the DC158</b>	<ol style="list-style-type: none"><li>1. Check the power outlet.</li><li>2. Check the connection. Refer to <a href="#">4.2.2 Connecting to external devices in Chapter 4 Installation and Connections</a> in this manual.</li><li>3. Check the signal sources [SOURCE]. Refer to <a href="#">7.1 Switching image sources in Chapter 7 Descriptions of major functions</a> in this manual.</li><li>4. Check the settings for the projector source. Refer to the projector's user manual.</li><li>5. Check if DIP Switch is properly set. Refer to <a href="#">Chapter 5 DIP Switch</a> for related settings.</li></ol>
3	<b>Unable to focus</b>	Probably the document is too close to the lens. Press [ZOOM -] on the <b>remote control</b> or <b>control panel</b> . Or increase the distance between the lens and the document, and then press the [FOCUS] button on the right side of the lens.
4	<b>Cannot see the entire image</b>	Check Auto Image of the projector. Refer to the projector's user manual.
5	<b>Visual Presenter V2, Ladibug™ and other applications cannot be used simultaneously</b>	Visual Presenter V2, Ladibug™ and other applications cannot be used simultaneously. Please close the currently running applications and then execute the desired application.